

## APPLIANCE LIFT

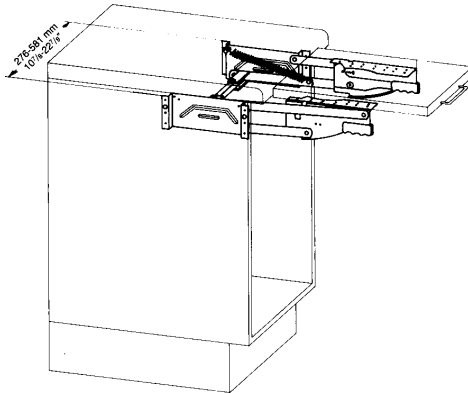
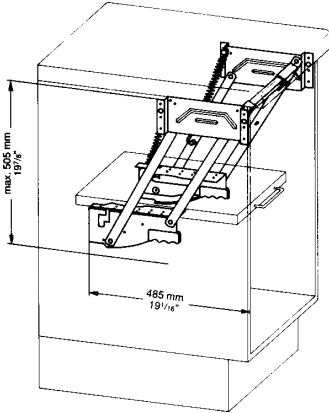

- Parallel lift-up fitting for kitchen appliances
- Swings out of base cabinet, will be in the final position, flush with the work surface and securely locked in position by safety device.
- For unlocking and swing-in-procedure, safety trigger has to be released with both hands.
- Two double tension springs provide for easy operation.
- For installation in 300 to 600mm wide cabinets.
- 22lb. load capacity.

ORDER #	FINISH	PKG.	UNIT
498-112-80-4151	WHITE	1	PR.

## HEAVY-DUTY MIXER LIFT

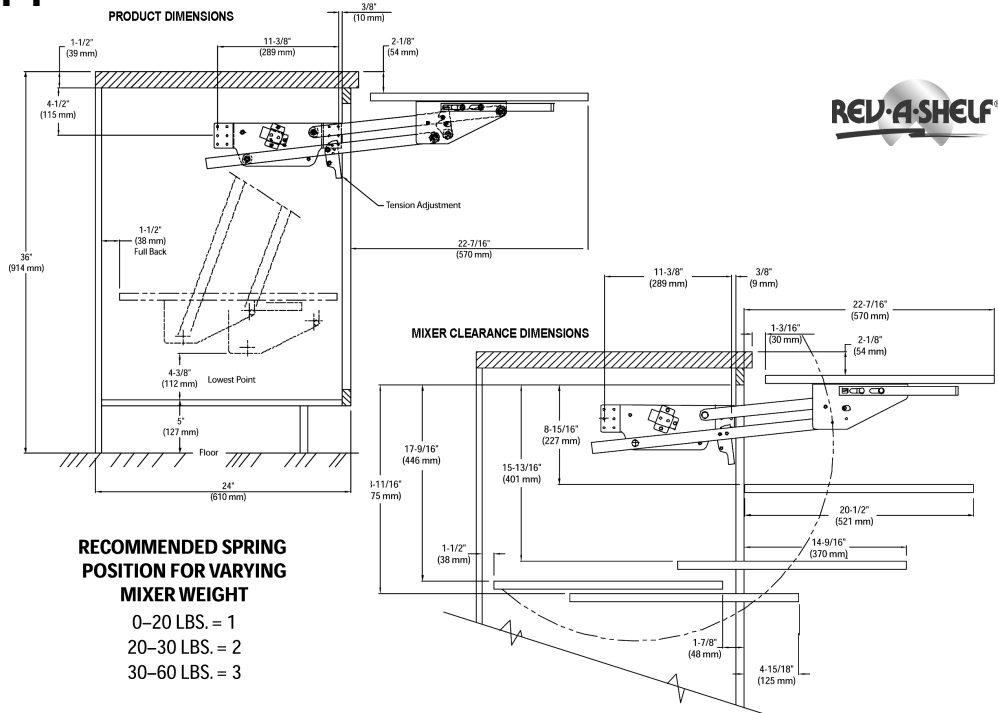

**RECOMMENDED SPRING POSITION FOR VARYING MIXER WEIGHT**

- 0-20 LBS. = 1
- 20-30 LBS. = 2
- 30-60 LBS. = 3

- New heavy duty lift mechanism with built-in shock dampeners.
- Needs to be installed in full-height base cabinet.
- 3 variable spring settings for optimal lifting of appliances up to 60 lbs.

ORDER #	FINISH	PKG.	UNIT
RAS-ML-HDCR	CHROME	1	SET

## HINGES FOR UNDERCABINET PULL-DOWN RACKS

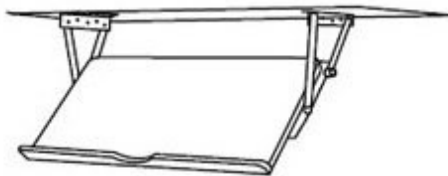

Mounted sample for example only. This set is hinges only, rack not included. Includes screws.

- Perfect for use on pull-down racks (not included) designed to fit underneath wall cabinets for space saving convenience.
- Bracket size (where mounted to underside of cabinet): 6"L x 1"W
- Bracket size (where mounted to shelf): 6-1/4"L x 1"W
- Overall Projection: when extended (open position): 8-1/2"; closed position: 4".

ORDER #	FINISH	PKG.	UNIT
UCR-HINGE-N	ZINC	1	PAIR

Decorative Hardware

Hinges

**Kitchen Organizers**

Cabinet Organizers

Drawer Slides

## CUTLERY TRAYS - GLOSSY FINISH



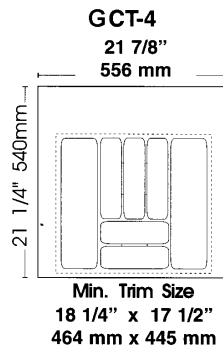
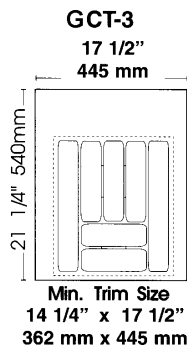
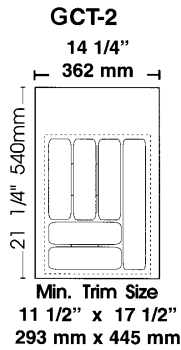
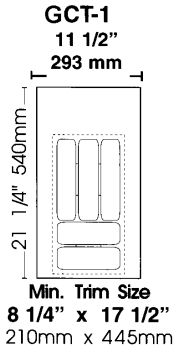

- 2-3/8" Deep.
- Hi-impact rubberized polystyrene that is durable and tough, and can be custom cut to fit your cabinet drawer size.
- \* Available in white (W) or silver (S) gloss finish, easily cleanable with soap and water.

ORDER #	COLOR	PKG.	UNIT
GCT-1*-52	WHITE OR SILVER	1	EACH
GCT-2*-52	WHITE OR SILVER	1	EACH
GCT-3*-52	WHITE OR SILVER	1	EACH
GCT-4*-52	WHITE OR SILVER	1	EACH

## UTILITY TRAYS - GLOSSY FINISH



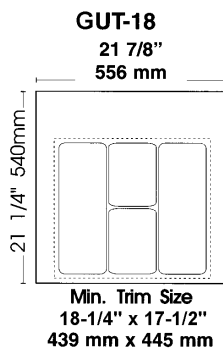
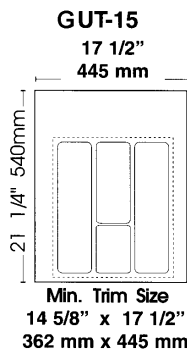
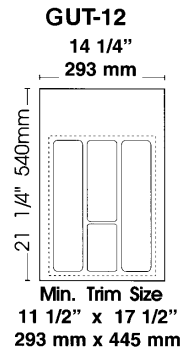
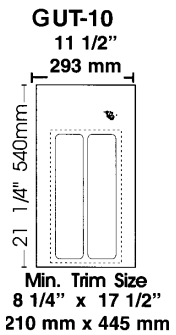

- 2-3/8" Deep.
- Hi-impact rubberized polystyrene that is durable and tough, and can be custom cut to fit your cabinet drawer size.
- White gloss finish, easily cleanable with soap and water.

ORDER #	COLOR	PKG.	UNIT
GUT-10W-52	WHITE	1	EACH
GUT-12W-52	WHITE	1	EACH
GUT-15W-52	WHITE	1	EACH
GUT-18W-52	WHITE	1	EACH

## ROLLING TRAY SYSTEM

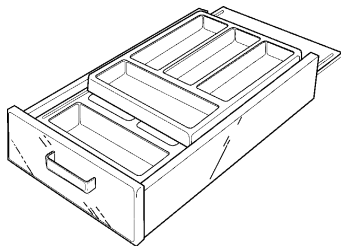

BASE  
UTILITY  
TRAYS

 ROLLING  
HALF  
TRAYS

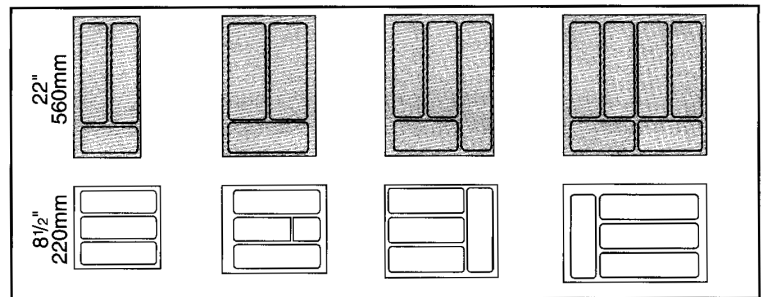

- (3H) Half Tray System - 3-1/8" Shallow Kit: No need to modify drawer box. Cut to fit bottom tray to existing drawer dimensions.
- Requires 3-1/8" min. opening clearance.
- Base Tray: 1-5/8" deep.
- Two-tier system includes shallow utility tray and full-size cutlery tray.
- Top rolling tray requires no trimming & is easily removable from the drawer.
- High gloss finish; thick-gauge polystyrene.

ORDER #	O/A TRAY SIZE	MIN. TRIM SIZE	COLOR	PKG.	UNIT
RT10-3H	11-3/4" x 16-3/4"	8-3/4" x 16-3/4"	WHITE	1	EACH
RT12-3H	14-1/2" x 16-3/4"	11-3/4" x 16-3/4"	WHITE	1	EACH
RT14-3H	17-3/4" x 16-3/4"	14-3/4" x 16-3/4"	WHITE	1	EACH
RT18-3H	21-3/4" x 16-3/4"	17-3/4" x 16-3/4"	WHITE	1	EACH

## VANITY DRAWER ORGANIZER

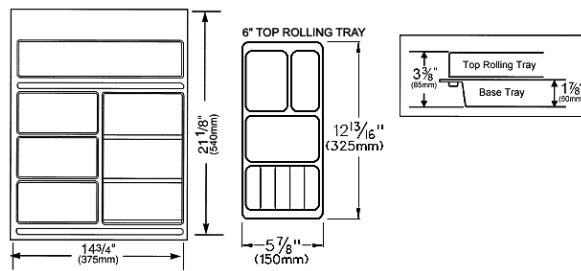



- Base tray with 6" top rolling tray.
- Minimum trim size: 12-5/8" x 16-1/2"D.

ORDER #	FINISH	PKG.	UNIT
COSK-18	WHITE	1	EACH

## CUTLERY TRAY INSERT - WOOD CLASSICS



4WCT-1 Overall: 14-5/8" W x 22" D  
Min. Trim Size: 8-3/4" W x 15-1/2" D



4WCT-3 Overall Size: 20-5/8" W x 22" D  
Min. Trim Size: 14-1/4" W x 15-1/2" D



- Cut to size, drop-in installation.
- 2-7/8" High.

ORDER #	COLOR	PKG.	UNIT
4WCT-1	WOOD	1	SET
4WCT-3	WOOD	1	SET

## UTILITY TRAY INSERT - WOOD CLASSICS



4WUT-1 Overall: 18-1/2" W x 22" D  
Min. Trim Size: 8-1/8" W x 17" D



4WUT-3 Overall Size: 24" W x 22" D  
Min. Trim Size: 12" W x 17-5/8" L



- Cut to size, drop-in installation.
- 2-7/8" High.

ORDER #	COLOR	PKG.	UNIT
4WUT-1	WOOD	1	SET
4WUT-3	WOOD	1	SET

## UNIVERSAL SPICE TRAY



- Textured finish.
- Trays size: 50"W x 21"D,
- Trimmable to any size.
- 4-1/2" minimum clearance.
- Best utilized w/22" slides for maximum accessibility.
- Engineered to fit all spice containers and provide easy accessibility, even in the back row.



ORDER #	COLOR	PKG.	UNIT
ST50-21A-52	ALMOND	1	SET
ST50-21W-52	WHITE	1	SET

## SPICE DRAWER INSERT



- Designed to secure spice containers and keep them easily accessible.
- Trimmable to fit any drawer precisely.
- Glossy finish.



ORDER #	COLOR	PKG.	UNIT
ST-2GW-52	WHITE	1	EACH

## SPICE DRAWER INSERT - WOOD CLASSICS

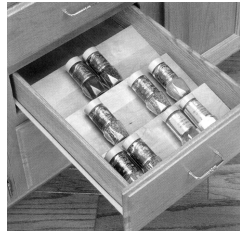

- Tiered configuration for total organization and easy access.
- Birch/Maple coated with UV-cured clear finish.
- 1-1/2" deep.



ORDER #	SIZE	PKG.	UNIT
4SDI-18	16"W x 19-3/4"L	1	SET
4SDI-24	22"W x 19-3/4"L	1	SET

## TRA-STA DEEP DRAWER KIT



- Modular and adjustable organizer allows for organization of pots, pans, lids or plates, bowls and dishes.
- Design segments for any size storage or any size deep drawer.
- Features 3 prefinished 11" x 24" maple dividers and 6 predrilled mounting rails.
- Easily trimmed for various drawer depths.



ORDER #	SPECIES	PKG.	UNIT
C0480MNL1	MAPLE	1	KIT

## EXTRUDED TIP-OUT TRAYS



6541 SLIM SERIES

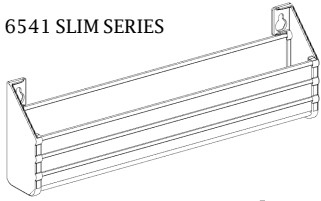

6551 SERIES

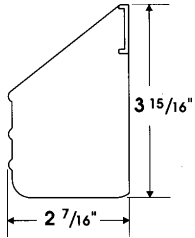
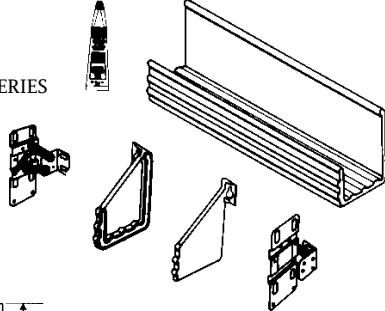

6551 SERIES

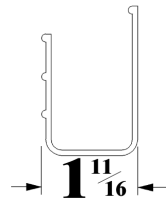

6541 SLIM SERIES

- Screws included with hinges.
- **Self-Holdin®** hinges mount easily to all construction types, provide a self-closing feature and are totally concealed.
- Each set comes complete with a mounting template and illustrated installation instructions.

ORDER #	DESCRIPTION	COLOR	PKG.	UNIT
<b>6541 SLIM SERIES TRAY SETS</b>				
6541-36-11-4	36" TRAY ONLY	WHITE	20	EACH
6541-36-15-4	36" TRAY ONLY	ALMOND	20	EACH
6541-36-11-52	36" TRAY W/2PR HINGES & END CAPS	WHITE	1	SET
6541-36-15-52	36" TRAY W/2PR HINGES & END CAPS	ALMOND	1	SET
6541-36-17-52	36" TRAY W/2PR HINGES & END CAPS	SILVER	1	SET
6542-97-11-4	HINGES & END CAPS	WHITE	40	PAIR
6542-97-15-4	HINGES & END CAPS	ALMOND	40	PAIR
<b>6551 SERIES CUSTOM SIZE TRAY SETS</b>				
6551-36-11-52	36" TRAY W/2PR HINGES & END CAPS	WHITE	1	SET
6551-36-15-52	36" TRAY W/2PR HINGES & END CAPS	ALMOND	1	SET
6552-97-11-4	HINGES, END CAPS & ADHESIVE	WHITE	40	PAIR
6552-95-0220	HINGES	ZINC	40	PAIR
<b>6571 SERIES BULK TIP-OUT TRAY SYSTEM</b>				
6571-36-11-4	36" TRAY ONLY	WHITE	20	EACH
6571-72-11-4	72" TRAY ONLY	WHITE	20	EACH
ST-97-11-4	END CAPS	WHITE	40	PAIR
6571-60-52	ADHESIVE - 3 GRAM TUBE	-	1	EACH

## MOLDED POLYMER TIP-OUT TRAY SETS

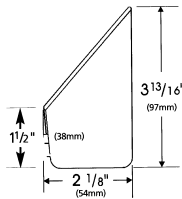
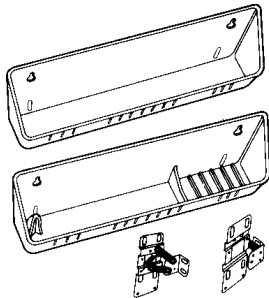

- **Set Contains:** 1-standard and 1-accessory tray & 2 pair of Self-Holdin® hinges, mounting template & instructions.

ORDER #	TRAY WIDTH	COLOR	PKG.	UNIT
6572-11-11-52	11-1/4"	WHITE	1	SET
6572-11-15-52	11-1/4"	ALMOND	1	SET
6572-11-17-52	11-1/4"	SILVER	1	SET
6572-14-11-52	14-1/4"	WHITE	1	SET
6572-14-15-52	14-1/4"	ALMOND	1	SET
6572-14-17-52	14-1/4"	SILVER	1	SET

## MOLDED POLYMER TIP-OUT TRAYS

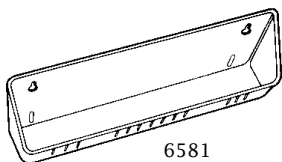

6581

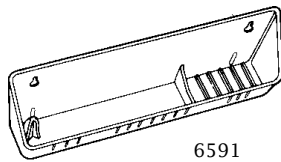

6591

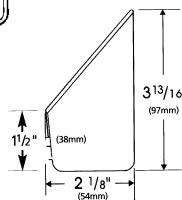

- Bulk, sold by the each, hinges sold separately.

ORDER #	TRAY WIDTH	COLOR	PKG.	UNIT
6581-11-11-4	11-1/4"	WHITE	40	EACH
6581-11-15-4	11-1/4"	ALMOND	40	EACH
6581-14-11-4	14-1/4"	WHITE	40	EACH
6581-14-15-4	14-1/4"	ALMOND	40	EACH
6591-11-11-4	11-1/4"	WHITE	40	EACH
6591-14-11-4	14-1/4"	WHITE	40	EACH



## TIP-OUT TRAYS WITH STOPS

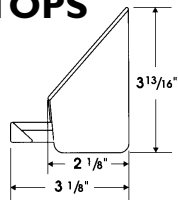

• Bulk, sold by the each, hinges sold separately.

ORDER #	TRAY WIDTH	FINISH	PKG.	UNIT
6561-11-11-4	11"	WHITE	40	EACH
6561-11-15-4	11"	ALMOND	40	EACH
6561-14-11-4	14"	WHITE	40	EACH
6561-14-15-4	14"	ALMOND	40	EACH

## STAINLESS STEEL FALSE FRONT TRAYS

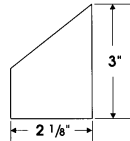
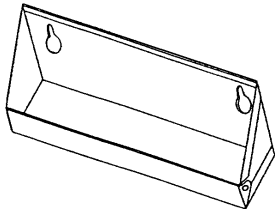

- 6581: without tab stops
- Bulk, sold by the each, hinges sold separately.

ORDER #	TRAY WIDTH	FINISH	PKG.	UNIT
6581-11-5	11-1/4"	S. STEEL	20	EACH
6581-14-5	14-1/4"	S. STEEL	20	EACH
6581-16-5	16"	S. STEEL	20	EACH
6581-19-5	19"	S. STEEL	20	EACH
6581-25-5	25"	S. STEEL	20	EACH
6581-28-5	28"	S. STEEL	20	EACH

## TIP-OUT TRAY SCISSOR HINGES

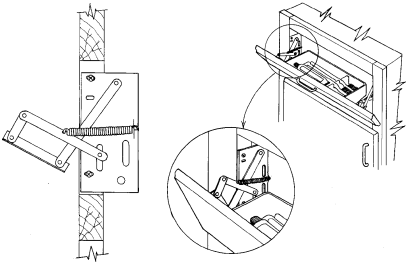

- 3-3/4"H x 1-3/4"D x 3/4"W.
- Spring loaded self-closing concealed hinge.
- Fits traditional frame or contemporary cabinetry.
- Internal stop, for use with trays w/out stops.
- Open smoothly and evenly on any length panel.



ORDER #	COLOR	PKG.	UNIT
SH-10	ZINC	10	PAIR

## TIP-OUT TRAY HINGES

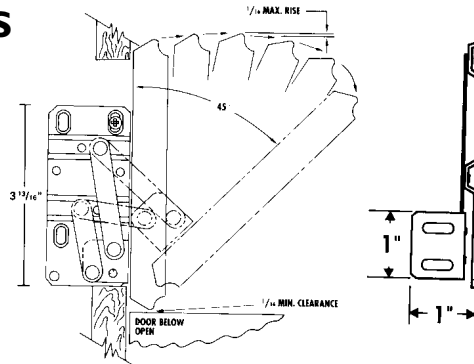

- Self-Holdin® hinges mount easily to all construction types, feature a self-closing and tip-open function and are totally concealed.
- Less than 2mm of clearance is needed for the countertop, and no clearance is needed below the false front.

ORDER #	COLOR	PKG.	UNIT
6552-95-0220-4	ZINC	40	PAIR

## TIP-OUT TRAY HINGES

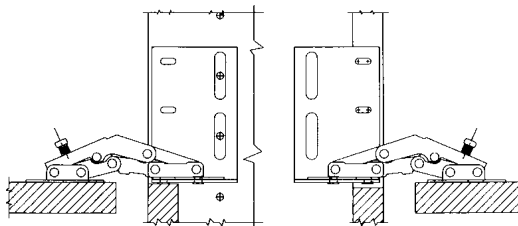
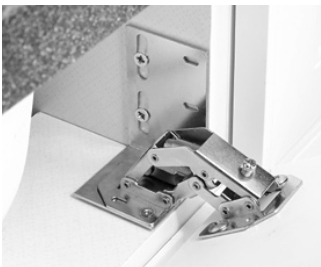

FRAMELESS CABINET

FACEFRAME CABINET



- Designed for long sink front or cooktop false panels in both traditional and contemporary cabinetry.
- Opening angle can be easily adjusted from 45° to 90°.
- Chrome plating allows for installation in any application.

ORDER #	COLOR	PKG.	UNIT
6552-ETH-10	ZINC	10	PAIR

## FALSE FRONT CLIP

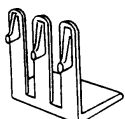

- Designed with staggered jaws to grip uneven wood sections.
- Permits false front panel above sink doors to be easily snapped into place.
- For 3/4" material.



ORDER #	COLOR	PKG.	UNIT
1931-32	WHITE	100	EACH

## DOOR MOUNT SPICE RACK



- Basket depths: 2-3/8" and 4-1/8".

ORDER #	HEIGHT	WIDTH	COLOR	PKG.	UNIT
565-8-52	21-3/8"	7-7/8"	WHITE	1	EACH
565-10-52	21-3/8"	10-5/8"	WHITE	1	EACH
565-14-52	21-3/8"	13-5/8"	WHITE	1	EACH

## ADJUSTABLE DOOR MOUNT SPICE RACK - WOOD CLASSICS



- Overall Depth: 4".
- Features adjustable shelves, a UV-cured clear finish and generous shelf space to house spice bottles up to 2-3/8" diameter.

ORDER #	HEIGHT	WIDTH	FINISH	PKG.	UNIT
4ASR-15	25"	10-1/8"	WOOD	1	EACH
4ASR-18	25"	13-1/8"	WOOD	1	EACH
4ASR-21	25"	16-1/8"	WOOD	1	EACH

## DOOR MOUNT SPICE RACK - WOOD CLASSICS



- Overall Depth: 3-1/8".
- Height between shelves: 8-5/8".
- Features a UV-cured clear finish, installs with 4 screws.

ORDER #	HEIGHT	WIDTH	FINISH	PKG.	UNIT
4SR-15	21-1/2"	9-5/8"	WOOD	1	EACH
4SR-18	21-1/2"	12-5/8"	WOOD	1	EACH
4SR-21	21-1/2"	15-5/8"	WOOD	1	EACH

We offer a huge selection of decorative and functional hardware online. Visit our online catalog today at [www.thehardwarehut.com](http://www.thehardwarehut.com)



**Hardware Hut.com**  
a division of Spokane Hardware Supply, Inc.

## STEMWARE & BOTTLE RACKS



3150



3250



3450



- New design features 8mm heavy-gauge wire construction and a hidden mounting plate.
- Inner dimension for stemware: 3-1/2"W.

ORDER #	DESCRIPTION	FINISH	PKG.	UNIT
3150-11CR	4-1/4"W x 11"D x 1-1/2"H	CHROME	1	EACH
3150-11SN	4-1/4"W x 11"D x 1-1/2"H	SAT. NICKEL	1	EACH
3150-16CR	4-1/4"W x 16"D x 1-1/2"H	CHROME	1	EACH
3150-16SN	4-1/4"W x 16"D x 1-1/2"H	SAT. NICKEL	1	EACH
3150-18CR	4-1/4"W x 18"D x 1-1/2"H	CHROME	1	EACH
3150-18SN	4-1/4"W x 18"D x 1-1/2"H	SAT. NICKEL	1	EACH
3250CR	4-1/4"W x 9"H x 5/8"THK.	CHROME	1	EACH
3250SN	4-1/4"W x 9"H x 5/8"THK.	SAT. NICKEL	1	EACH
3450-11CR	17"W x 11"D x 1-1/2"H	CHROME	1	EACH
3450-11SN	17"W x 11"D x 1-1/2"H	SAT. NICKEL	1	EACH

## STEMWARE RACK

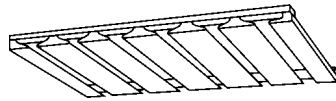

ORDER #	SPECIES	PKG.	UNIT
S9630QUF1	ALDER	1	EACH
S9630CUF1	CHERRY	1	EACH
S9630HUF1	HICKORY	1	EACH
S9630MUF1	MAPLE	1	EACH
S9630OUF1	RED OAK	1	EACH

We offer a huge selection of decorative and functional hardware online. Visit our online catalog today at [www.thehardwarehut.com](http://www.thehardwarehut.com)



**Hardware Hut.com**  
a division of Spokane Hardware Supply, Inc.

Decorative Hardware

Hinges

**Kitchen Organizers**

Cabinet Organizers

Drawer Slides

## WINE BOTTLE RACK



- Solid wood wine bottle rack.
- Holds eleven wine bottles and is easily trimmed for any size cabinet or shelf.
- Sanded and ready to finish.
- Sold per pair.



ORDER #	SPECIES	SIZE	PKG.	UNIT
S9200CUF1	CHERRY	48" L	1	PR
S9200HUF1	HICKORY	48" L	1	PR
S9200MUF1	MAPLE	48" L	1	PR
S9200OUF1	RED OAK	48" L	1	PR

## WINE BOTTLE LATTICE PANEL

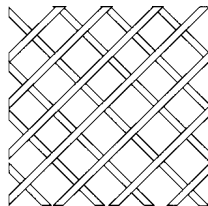

- Panels are produced from sturdy moldings 3/4" thick x 7/8" wide with radius edges.
- Glued and mechanically fastened at joints.
- Bottle openings are 4" x 4".
- Easily cut to desired size.
- Sold per pair.



ORDER #	SPECIES	SIZE	PKG.	UNIT
WRL1736AL	ALDER	17"W x 36"H	1	PAIR
WRL1736CH	CHERRY	17"W x 36"H	1	PAIR
WRL1736HI	HICKORY	17"W x 36"H	1	PAIR
WRL1736MA	MAPLE	17"W x 36"H	1	PAIR
WRL1736RO	RED OAK	17"W x 36"H	1	PAIR
WRL2430AL	ALDER	30"W x 24"H	1	PAIR
WRL2430CH	CHERRY	30"W x 24"H	1	PAIR
WRL2430HI	HICKORY	30"W x 24"H	1	PAIR
WRL2430MA	MAPLE	30"W x 24"H	1	PAIR
WRL2430RO	RED OAK	30"W x 24"H	1	PAIR
WRL2443AL	ALDER	24"W x 43"H	1	PAIR
WRL2443CH	CHERRY	24"W x 43"H	1	PAIR
WRL2443HI	HICKORY	24"W x 43"H	1	PAIR
WRL2443MA	MAPLE	24"W x 43"H	1	PAIR
WRL2443RO	RED OAK	24"W x 43"H	1	PAIR

## SONOMA SERIES WINE RACK

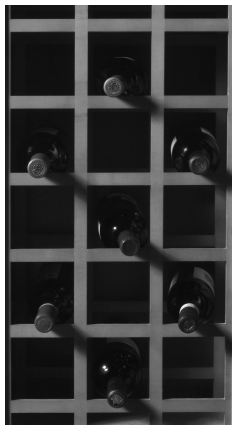

- Panels are produced from sturdy moldings 3/4" thick x 7/16" wide with radius edges.
- Bottle openings are 3-3/4" x 3-3/4"
- Sold per pair.
- L3260 - 21 full bottle openings
- L3240 - 24 full bottle openings
- L3220 - 28 full bottle openings



ORDER #	SPECIES	SIZE	PKG.	UNIT
L3260QUF9	ALDER	17"W x 36"H	1	PAIR
L3260CUF9	CHERRY	17"W x 36"H	1	PAIR
L3260HUF9	HICKORY	17"W x 36"H	1	PAIR
L3260MUF9	MAPLE	17"W x 36"H	1	PAIR
L3240QUF9	ALDER	24"W x 30"H	1	PAIR
L3240CUF9	CHERRY	24"W x 30"H	1	PAIR
L3240HUF9	HICKORY	24"W x 30"H	1	PAIR
L3240MUF9	MAPLE	24"W x 30"H	1	PAIR
L3220QUF9	ALDER	24"W x 43"H	1	PAIR
L3220CUF9	CHERRY	24"W x 43"H	1	PAIR
L3220HUF9	HICKORY	24"W x 43"H	1	PAIR
L3220MUF9	MAPLE	24"W x 43"H	1	PAIR

## RUSSIAN RIVER WINE RACK

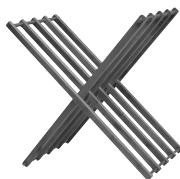

- Features modular design and flexible options.
- This "X" rack folds down on itself and is trimmable for depth.
- Panels are produced from sturdy moldings 3/4" thick x 7/16".



ORDER #	SPECIES	SIZE	PKG.	UNIT
WS100CUF1	CHERRY	22-3/8"	1	EACH
WS100MUF1	MAPLE	22-3/8"	1	EACH
WS100QUF1	ALDER	22-3/8"	1	EACH
WS110CUF1	CHERRY	30-7/8"	1	EACH
WS110MUF1	MAPLE	30-7/8"	1	EACH
WS110QUF1	ALDER	30-7/8"	1	EACH

## PLATE DISPLAY UNIT

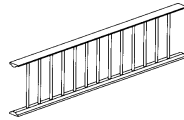

- Fully assembled unit with tasteful moulding shape & dowels of the same species.
- Mouldings have trim area of 1-1/2" on each end.
- Dowels spaced 2" on center.
- 36"L x 13-1/16"H x 1-1/2"W.
- Sold per pair.

ORDER #	COLOR	PKG.	UNIT
NPD-36-CH	CHERRY	1	PAIR
NPD-36-HI	HICKORY	1	PAIR
NPD-36-RO	RED OAK	1	PAIR
NPD-36-MA	MAPLE	1	PAIR

## TRA-STA ORGANIZER



- Four prefinished Maple veneer dividers slide in grooved and predrilled top and bottom rails.
- Designed to be fastened in multiple locations to accept a variety of pots, pans, lids or cookie sheets.
- Easily trimmable to fit any size cabinet.
- Set Includes: 4 Finished Dividers & 8 drilled rails.

ORDER #	COLOR	PKG.	UNIT
TS2424	MAPLE	1	SET

## APPLIANCE GARAGES - CORNER UNIT



- Solid wood door & face frame.
- End panels are veneer faced and backed on 3/8" MDF, using plain-sliced veneer.
- Hoffco Spring Tension Track System for smooth, non-binding operation.
- Doweled joints.
- Easy to install.
- 17"W x 18-1/2"H x 11-7/8"D - fits standard 24" corner.

ORDER #	COLOR	PKG.	UNIT
AG-100SAL	ALDER	1	EACH
AG-100CSC	CHERRY	1	EACH
AG-100CSH	HICKORY	1	EACH
AG-100CSM	MAPLE	1	EACH
AG-100CSR	RED OAK	1	EACH

## APPLIANCE GARAGE - EURO CORNER UNIT

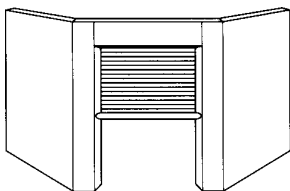

- Modified solid-look painted tambour door (MP-7) on unique mitre-folded face frame & end panels.
- Vinyl laminated end panels/face frame/top rail.
- Hoffco Spring Tension Track System for smooth, non-binding operation.
- Easy to install.
- 17"W x 18-1/2"H x 11-7/8"D - fits standard 24" corner.

ORDER #	COLOR	PKG.	UNIT
AG-200CW	WHITE	1	EACH

## STAINLESS COMBINATION KIT - FOR FACE FRAME APPLICATIONS



shown installed in wood surround, not included.



- Preassembled Stainless Steel finish tambour doors for appliance garages and other cabinetry applications.
- Spring Tension Track Systems for face frame construction
- European design, compliments stainless steel kitchen applications.
- Ready to install quickly into cabinetmaker's frame

ORDER #	SIZE	PKG.	UNIT
C02-ST5-1	15"x18"	1	EACH
C02-ST5-2	24"x18"	1	EACH
C02-ST5-3	30"x18"	1	EACH

**SHS - One complete source for all of your finish hardware needs.**

Decorative Hardware

Hinges

**Kitchen Organizers**

Cabinet Organizers

Drawer Slides

## BREADBOARD

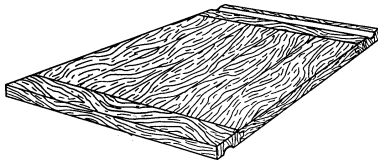

- All hardwood (alder) construction electronically laminated and sealed to minimize moisture penetration.
- Finger pull each end allows board to be reversible, alder on one end, oak on the other.
- All boards full 3/4" thick.

ORDER #	DESCRIPTION	PKG.	UNIT
BB1622K	16" x 22"	12	EACH
BB1822K	18" x 22"	6	EACH
BB2422K	24" x 22"	6	EACH
121 21-1/2"	BREADBOARD SLIDES	25	PAIR

## BREADBOARD SLIDES

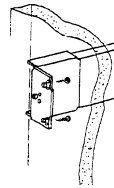
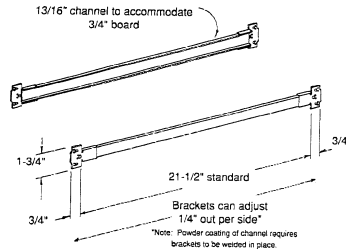
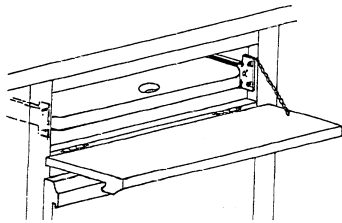

BRACKET CAN BE BENT 90° FOR FACE FRAME MOUNTING



- 21-1/2" length.
- Zinc finish.

ORDER#	PKG.	UNIT
121 21-1/2"	25	PR

## KNIFE HOLDER/CUTTING BOARD DRAWER SYSTEM



- State-of-the art combination knife holder/cutting board system glides on full-extension ball bearing slides.
- Features a removable mineral oil treated cutting board & 3 divided sections including a unique 7-slot knife holder compartment.
- **Overall Size:** 22-3/4"D x 4-1/2"H



ORDER #	WIDTH	PKG.	UNIT
4KCB-18	14-1/2"	1	EACH
4KCB-21	17-1/2"	1	EACH
4KCB-24	20-1/2"	1	EACH

## WOOD KNIFE BLOCK INSERT



- Trimmable knife block can be customized to various drawer sizes; includes divider rail to allow for block to be used with other drawer organizers.
- Includes 19 slots to store knives & a separate compartment for other utensils.
- **Overall Size:** 18-1/2"W X 22"D x 2-3/8"H



ORDER #	PKG.	UNIT
4WKB-1	1	EACH

## DOOR MOUNT CUTTING BOARD



- Birch/maple hardwood cutting board is mineral oil treated & the support racks are coated with a UV-cured clear finish.

### 4DMCB-15

- **Rack:** 9-1/2"W x 3"D x 8"H
- **Board:** 7-7/8"W x 1-1/4"D x 16"H

### 4DMCB-18

- **Rack:** 12-1/2"W x 3"D x 8"H
- **Board:** 10-7/8"W x 1-1/4"W x 16"H



ORDER #	PKG.	UNIT
4DMCB-15	1	EACH
4DMCB-18	1	EACH

## CUTTING BOARD/HOLDER

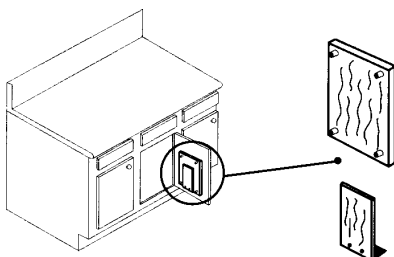

- Removable 10" x 14" cutting board with holder for mounting to inside of base cabinet door.
- Solid alder cutting board (a hardwood similar in appearance to cherry) with rubber feet attached.
- Mineral oil finish.
- 15"H x 14"W x 1-1/2"D\* Includes frame.



ORDER #	PKG.	UNIT
CB-1014	1	EACH

## TRAY DIVIDER

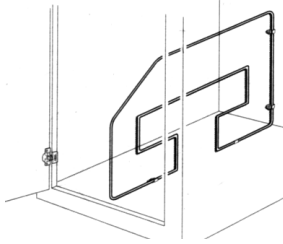

- Units are shipped complete with nylon fittings and screws.
- Heavy gauge 1/4" dia. steel wire.

ORDER #	HEIGHT	WIDTH	DEPTH	FINISH	PKG.	UNIT
TD12-W	12-1/4"	7/8"	19-3/4"	WHITE	10	EACH
TD18-W	18-1/4"	7/8"	19-3/4"	WHITE	10	EACH

## TRAY DIVIDERS - WHITE & PREMIERE CHROME



- Chrome or white tray dividers are a perfect organizer for your large baking sheets, serving dishes, cake pans & more.

ORDER #	HEIGHT	WIDTH	DEPTH	FINISH	PKG.	UNIT
597-12-10	12"	1/4"	20"	WHITE	10	EACH
597-18-10	18"	1/4"	20"	WHITE	10	EACH
597-12CR	12"	1/4"	20"	CHROME	10	EACH
597-18CR	18"	1/4"	20"	CHROME	10	EACH

## KITCHENMATE TRAY ROLL-OUT



- All-wood construction, prefinished and removable partitions
- 100 lb full extension ball bearing overtravel guides
- Pre-assembled and premounted to plywood sled for easy installation.

ORDER #	APPLICATION	SPECIES	PKG.	UNIT
T3194MNL1	9" BASE CABINET - 1 DIVIDER	MAPLE	1	EACH
T3195MNL1	12" BASE CABINET - 2 DIVIDERS	MAPLE	1	EACH
T3196MNL1	15" BASE CABINET - 3 DIVIDERS	MAPLE	1	EACH

## TOWEL RACKS

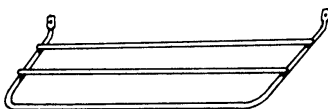

- 3 wire bars.
- Durable epoxy coated rack.
- Installs quickly with two screws (provided).



ORDER #	HEIGHT	WIDTH	DEPTH	COLOR	PKG.	UNIT
TB-W	6-1/4"	12-3/8"	4-1/2"	WHITE	10	EACH

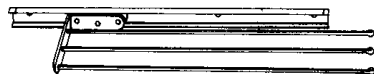

- Three bar rack, side-mounts to either side of the cabinet.
- Rack mounts with four screws.

ORDER #	LENGTH	WIDTH	FINISH	PKG.	UNIT
P793CHR	18"	5"	CHROME	10	EACH



- 3 prongs and 12" extension for accessibility.
- Mounting is universal for horizontal or vertical applications.
- **CONTAINS:** 1 - 5" wide Pull-Out, 3-prong Towel Holder with 12" extension with mounting screws.

ORDER #	LENGTH	WIDTH	DEPTH	FINISH	PKG.	UNIT
563-47-C	17-3/4"	5"	1-1/4"	CHROME	1	EACH
563-47	17-3/4"	5"	1-1/4"	WHITE	1	EACH

